

# BOTTOM RUNNER SLIDING DOOR SYSTEM

Bottom runner sliding door catalogue

---





## “Excellent sliding experience for wardrobe cabinet ”

Doors inset the cabinet and supply the easy assembly and smooth sliding motion, soft close can be optional for two doors and three doors.



# Bottom runner system

SWB005

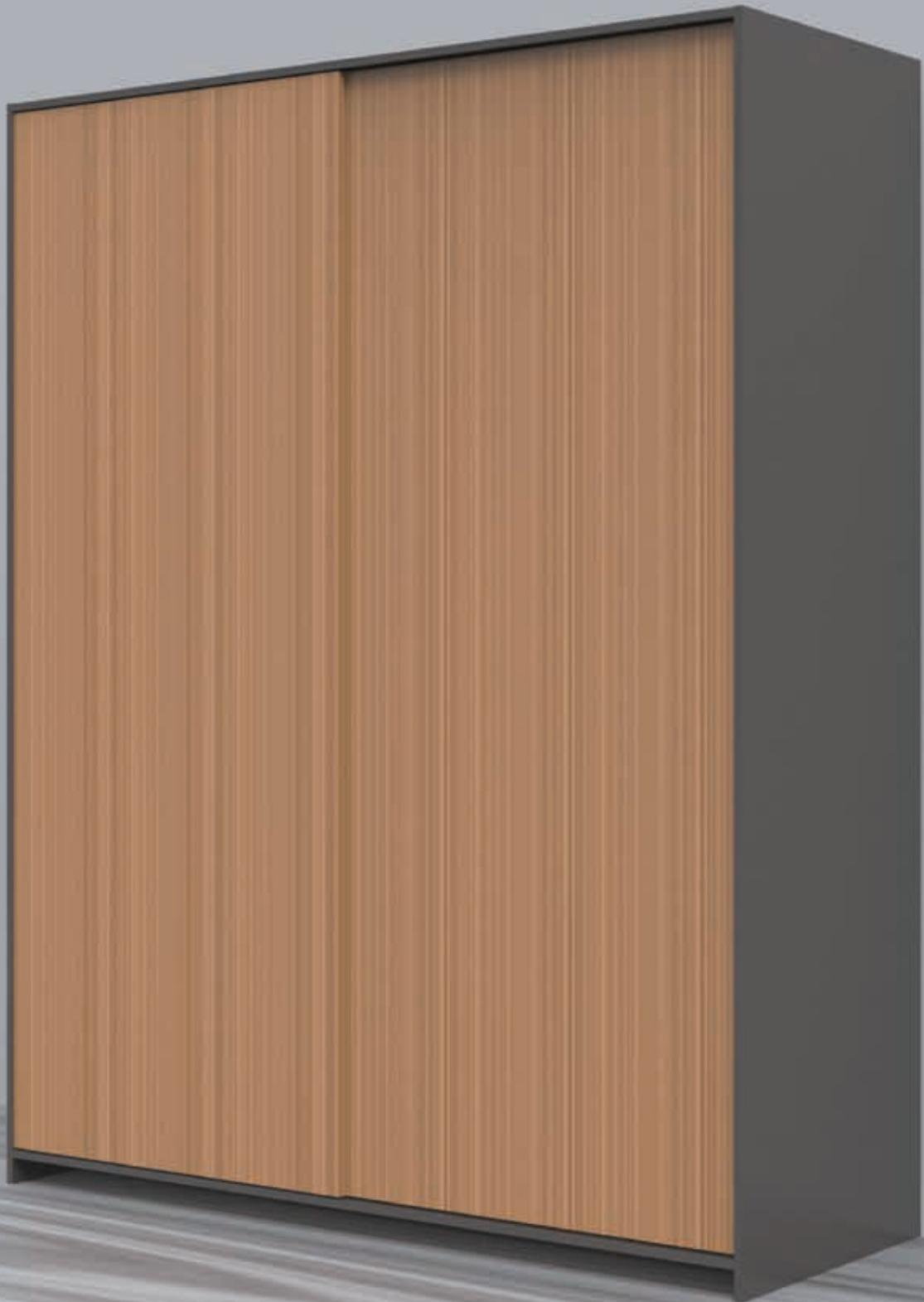





**SW sliding system**

Bottom runner sliding system - SWB005



- Bottom runner sliding system
- Recess mounting
- Soft-close system
- 50KG/door loading capacity
- Damper with anti jumping and anti-decoupling
- 500-1200mm door width
- Max. 20mm wooden door thickness
- Max. 34mm aluminium frame door thickness
- Door height ≤2500mm



	Item	Quantity (2 doors)	Quantity (3 doors)	Quantity (4 doors)
	Runner	8 pcs	12 pcs	18 pcs
	Damper	4 pcs	4 pcs	4 pcs
	Fixing accessories	1 pc	1 pc	1 pc
	ST4x16 screw	32 pcs	48 pcs	64 pcs
Item No.		SWB005-1	SWB005-2	SWB005-3

	Item	Item No.	Remark
	Rail set	SWB05-R	3000mm length;

## Installation dimension

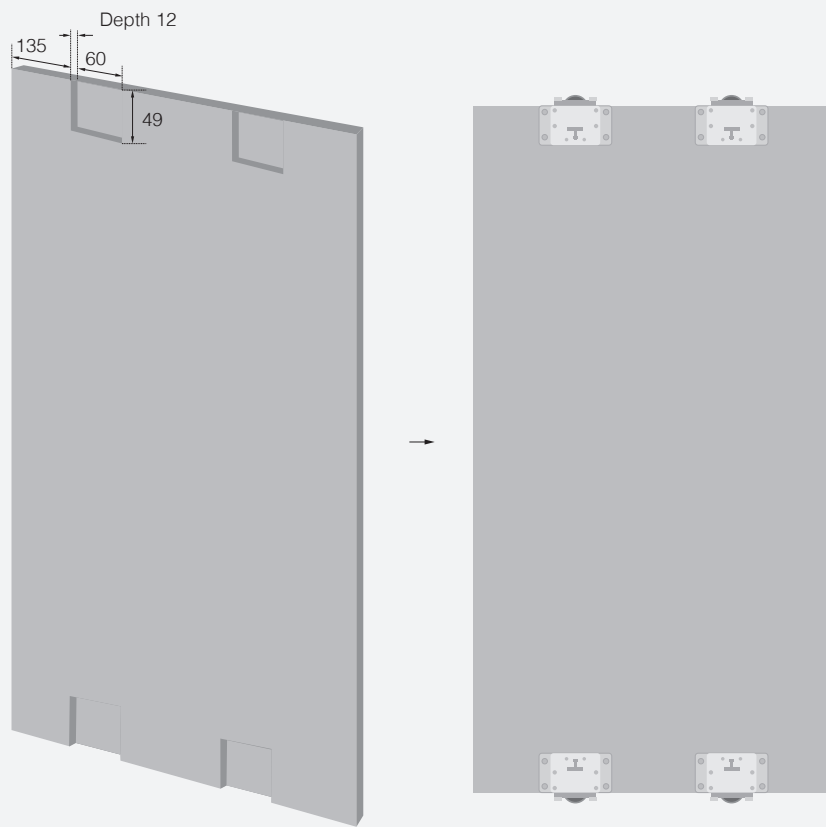

## Installation damper



Space required

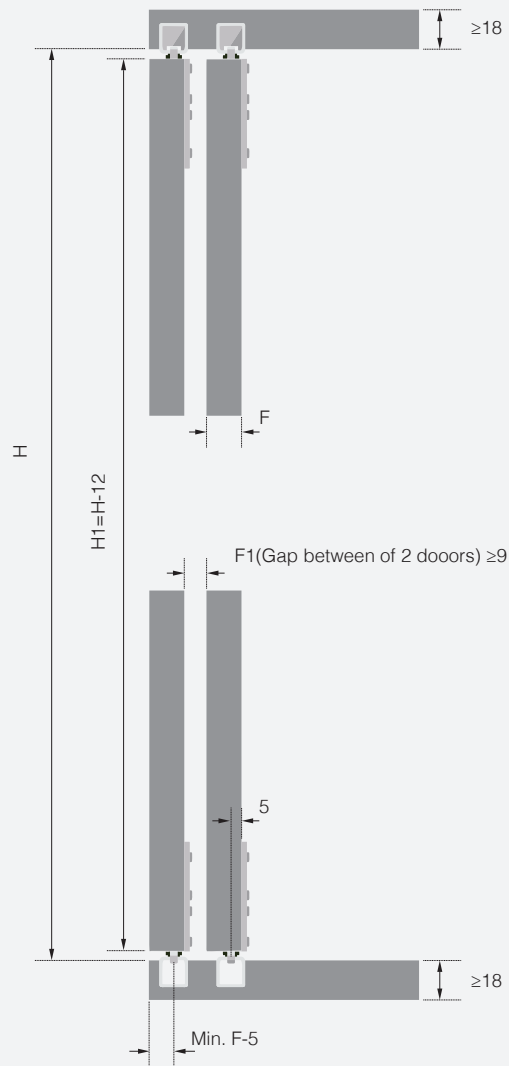

Slot dimension for rail

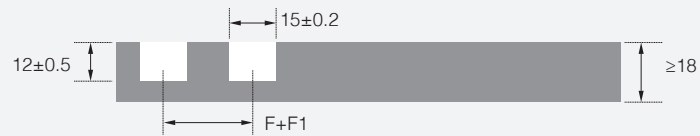

# Bottom runner system

SWB006





## SW sliding system

Bottom runner sliding system - SWB006

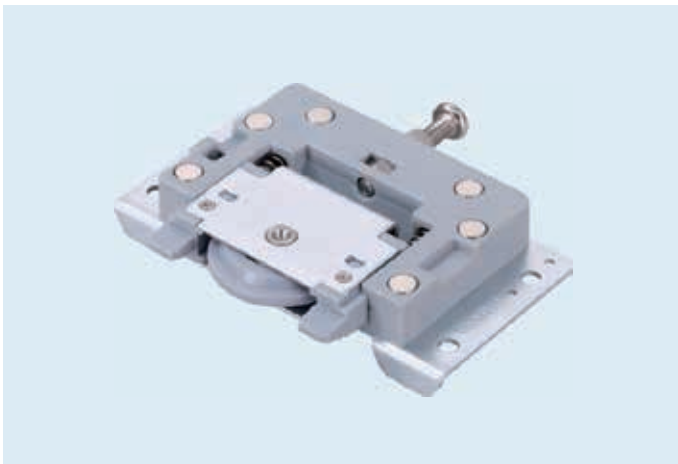

- Bottom runner sliding system
- Surface mounting
- Soft-close system
- 10-50KG/door loading capacity
- Damper with anti jumping and anti-decoupling
- 500-1200mm door width
- Max. 20mm wooden door thickness
- Max. 34mm aluminium frame door thickness
- Door height  $\leq 2500$ mm



	Item	Quantity (2 doors)	Quantity (3 doors)
	Upper runner	4 pcs	6 pcs
	Lower runner	4 pcs	6 pcs
	Damper	4 pcs	4 pcs
	Spacer	16 pcs	24 pcs
	Fixing accessories	1 pc	1 pc
	ST4x16 screw	32 pcs	48 pcs
Item No.		SWB006-1	SWB006-2

	Item	Item No.	Remark
	Rail set	SWB06-R	3000mm length;
	Upper and lower frame	SWB06-F1	3000mm length; Accessories of aluminium frame door
	Middle frame	SWB06-F2	3000mm length; Accessories of aluminium frame door
	Profile frame	SWB06-F3	3000mm length; Accessories of aluminium frame door

Installation dimension for wooden door

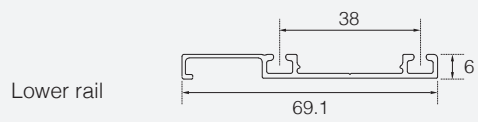
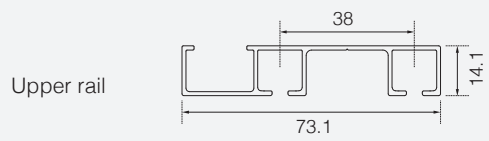
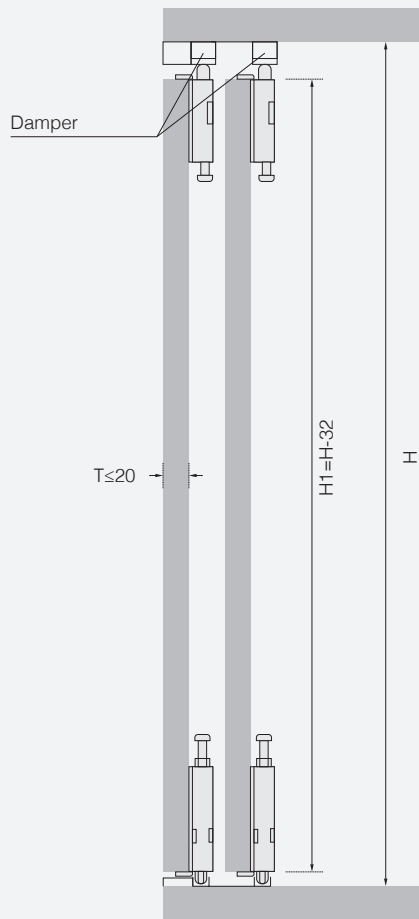

Installation dimension for aluminium frame door

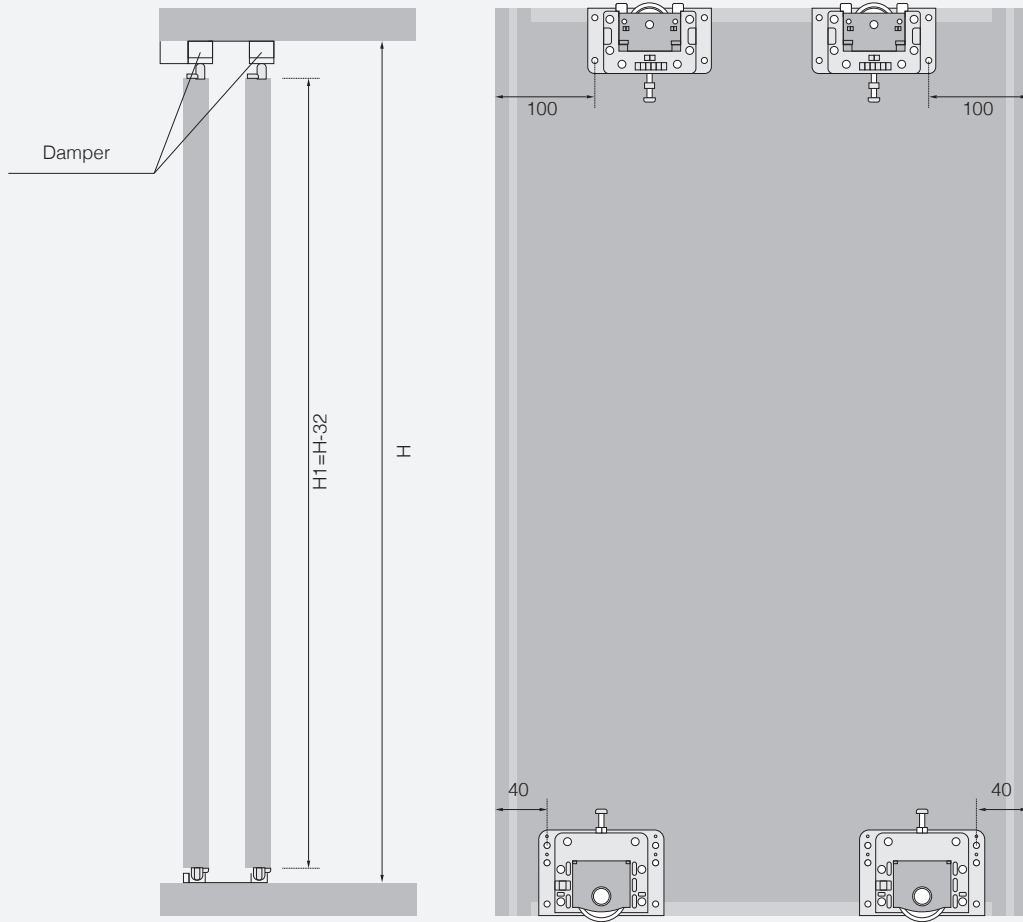

# Bottom runner system

SWB007









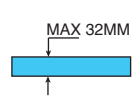
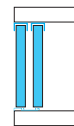

## SW sliding system

Bottom runner sliding system - SWB007



- Bottom runner sliding system
- Recess mounting
- Soft-close system
- 60KG/door loading capacity
- Damper with anti jumping and anti-decoupling
- 500-1200mm door width
- 18-32mm door thickness
- Door height ≤2500mm

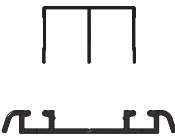

	Item	Quantity (2 doors)	Quantity (3 doors)
	Upper left runner	2 pcs	3 pcs
	Upper right runner	2 pcs	3 pcs
	Lower runner	4 pcs	6 pcs
	Damper	4 pcs	4 pcs
	Fixing accessories	1 pc	1 pc
	ST4x16 screw	16 pcs	24 pcs
	ST4x14 screw	12 pcs	18 pcs
	ST4x30 screw	8 pcs	8 pcs
Item No.		SWB007-1	SWB007-2

	Item	Item No.	Remark
	Upper and lower rails	SWB07-R20	3000mm length; For 18-20mm door tickness
		SWB07-R25	3000mm length; For 21-25mm door tickness
		SWB07-R32	3000mm length; For 26-32mm door tickness

## Rail dimension

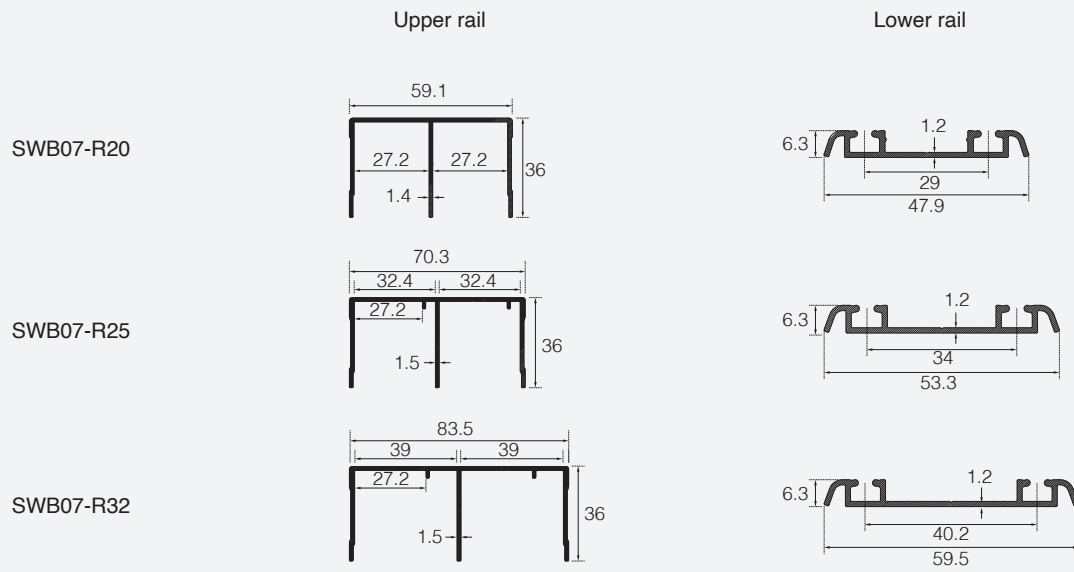

## Installation dimension

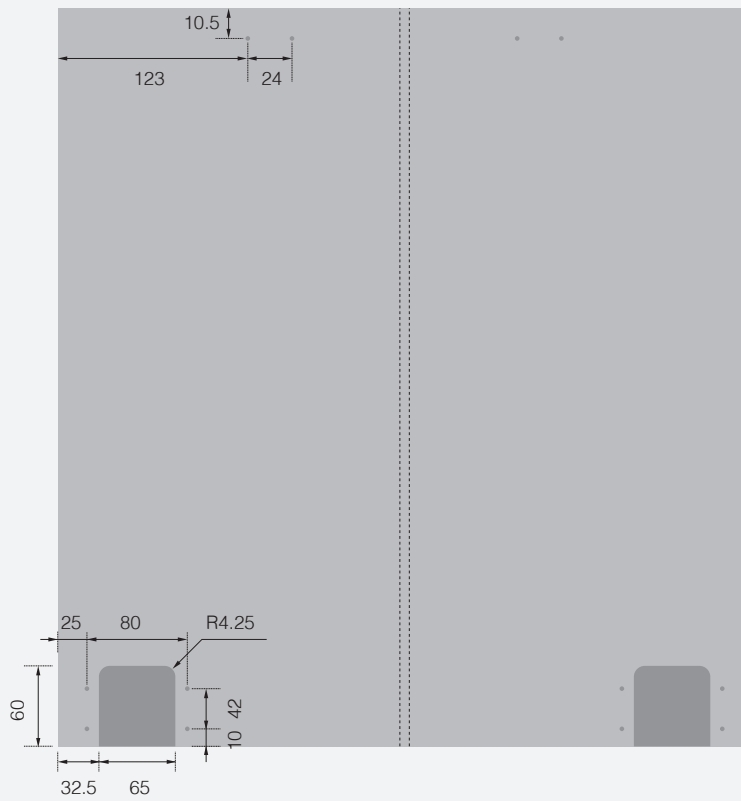

18-20mm Door thickness

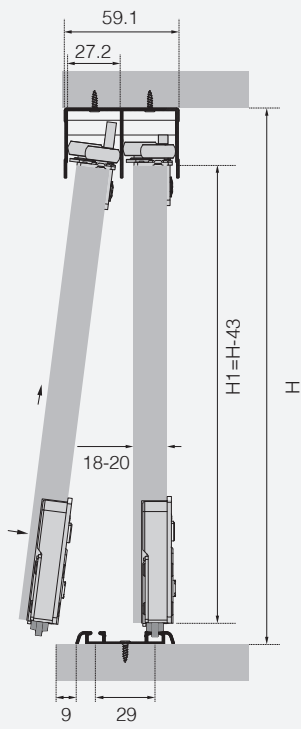

21-25mm Door thickness

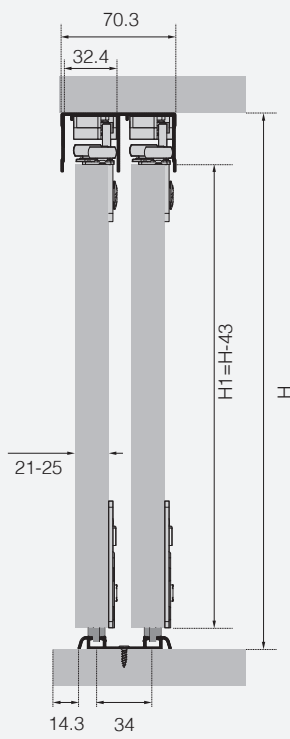

26-32mm Door thickness

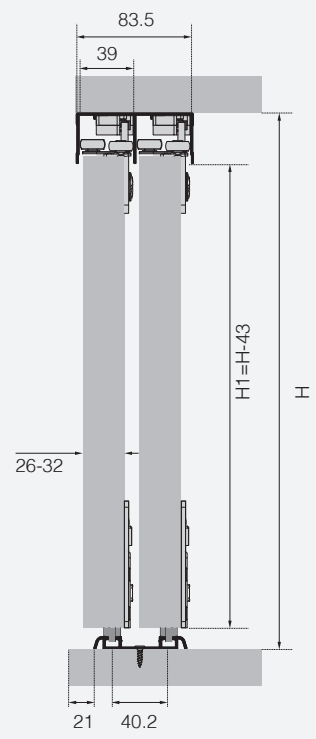

# Bottom runner system

SWB008





**SW sliding system**

Bottom runner sliding system - SWB008



- Bottom runner sliding system
- Surface mounting
- Soft-close system
- 60KG/door loading capacity
- Damper with anti jumping and anti-decoupling
- 500-1200mm door width
- 16-25mm wooden door thickness
- 16-34mm aluminium frame door thickness
- Door height ≤2500mm



**Order information**

	Item	Quantity (2 doors)	Quantity (3 doors)
	Upper left runner	2 pcs	3 pcs
	Upper right runner	2 pcs	3 pcs
	Lower runner	4 pcs	6 pcs
	Damper	4 pcs	4 pcs
	Fixing accessories	1 pc	1 pc
	Spacer	8 pcs	12 pcs
	ST4x14 screw	32 pcs	48 pcs
	ST4x30 screw	8 pcs	8 pcs
<b>Item No.</b>		<b>SWB008-1</b>	<b>SWB008-2</b>

	Item	Item No.	Remark
	Upper and lower rails	SWB08-R20	3000mm length; For 16-20mm door tickness
		SWB08-R25	3000mm length; For 21-25mm door tickness

Rail dimension

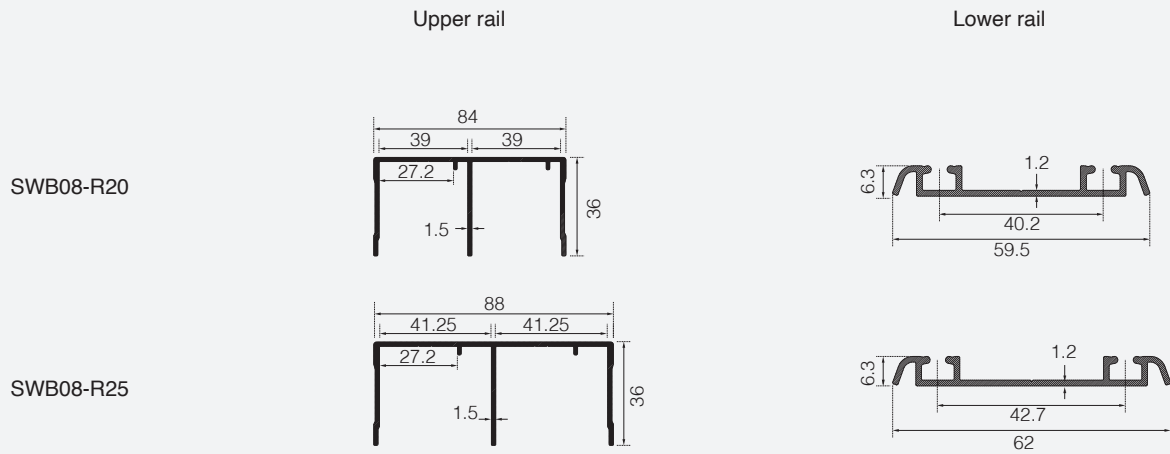

Rail dimension

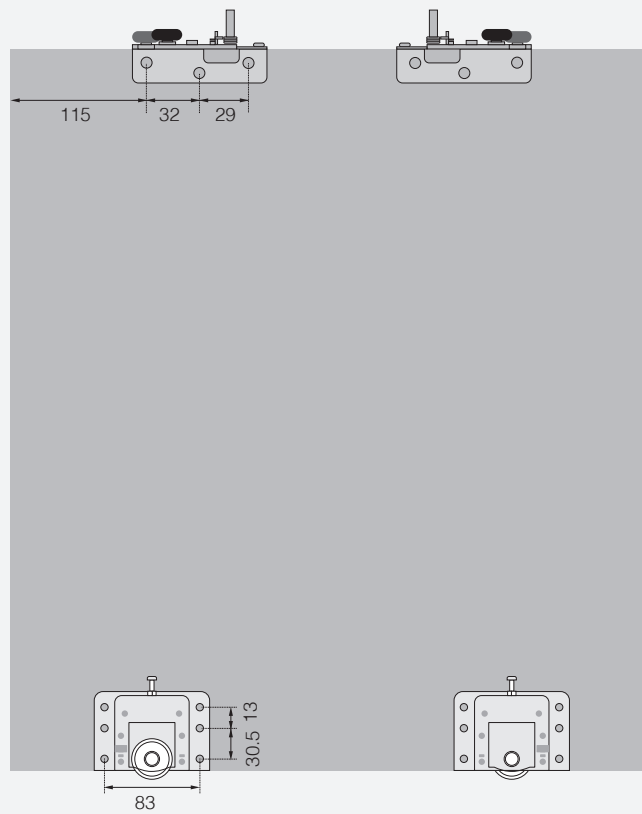

Aluminium frame door

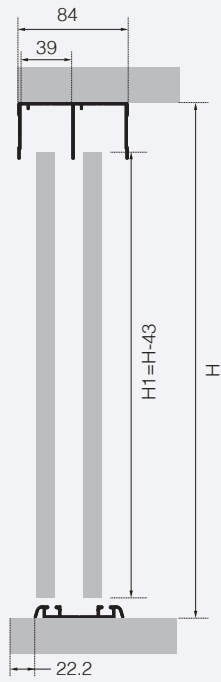

18-20mm Door thickness

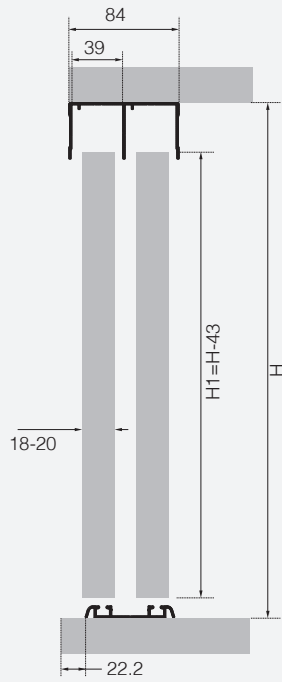

21-25mm Door thickness

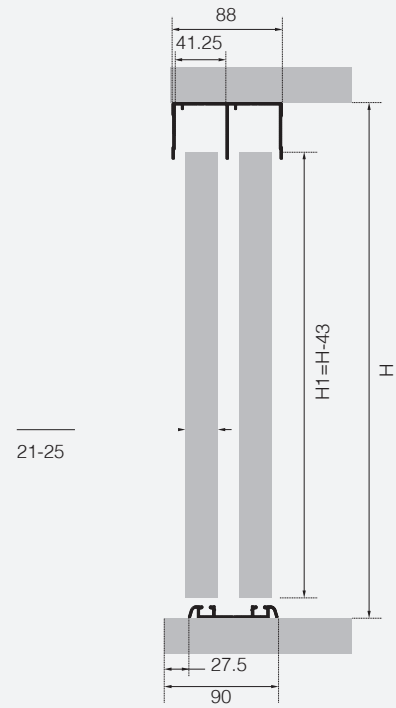

\* Aluminium frame door only apply SWB08-R20



For more information, please visit [CEMUX.COM](http://CEMUX.COM)  
or contact us email [CEMUX@CEMUX.CO.UK](mailto:CEMUX@CEMUX.CO.UK)

**CEMUX**  
LIVE YOUR LIFE

CEMUX TECHNOLOGY LTD

—  
Kilkeary,  
Nenagh,  
Co. Tipperary  
Ireland  
Tel: 00353 67 31471

